

'Luxury is a state of mind.'
L'Wren Scott

BauTeam presents...

BauCloset

Badea Bathrooms

BLV Bathrooms

Bauformat Kitchens

BauLux Kitchens

BT45 Kitchens





BAU CLOSET

Welcome to BauCloset - The path to a personalized closet and living space system!

At BauCloset, nothing comes off the shelf. Individualized solutions that fit your space like a made-to-measure suit. That is our specialty. In order to meet this requirement, every product is manufactured, inspected and carefully packaged in Germany with millimeter accuracy.

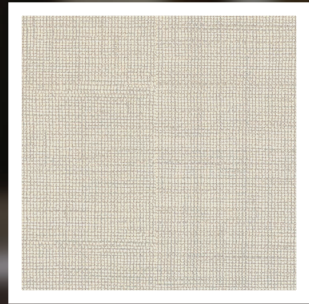

Fabric Sand

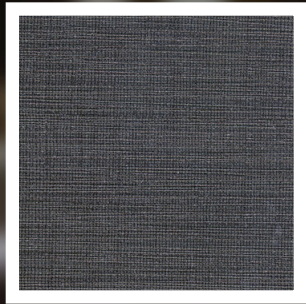

Fabric Slate



Maloja Cherry



Maloja Maple



Maloja Walnut



Matrix Dark



Matrix Oak



Tirano Ash Gray



Tirano Oak Black



Idea Curio

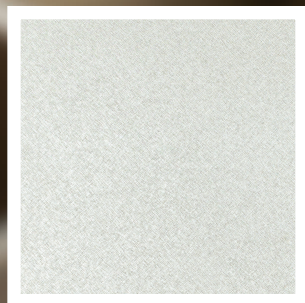

Idea Renio



Led hanging rail

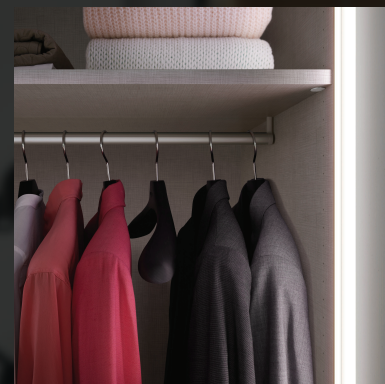

Gallery light



Shelf Led



Led side

Installation



TREND

offers a practical design-oriented storage solution which puts the emphasis on appearance, design and functionality. For a walk-in closet, a prestigious office space or for almost any living area; if you are looking for an especially stable system, then the Trend interior system is the right choice. Outer sides, inner sides and shelves are made of decor resin-coated 25 mm [1"] chipboard (Carb2).

TREND, a wardrobe system along with a walk-in closet possessing a contemporary modularity suitable to any space. The walk-in closet is distinguished by 1" vertical panels that bring out the solidity of their geometry. The frame side creates great formal lightness and emphasizes the wardrobes inner open units.

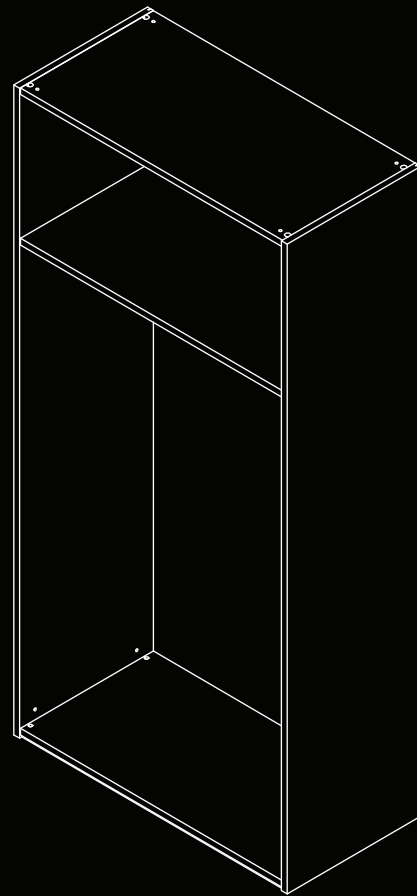

freestanding closet

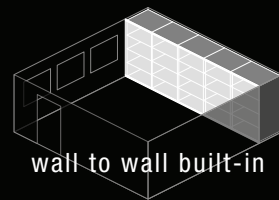

wall to wall built-in

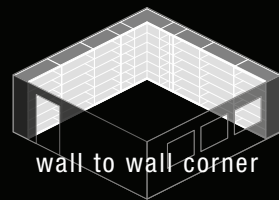

wall to wall corner

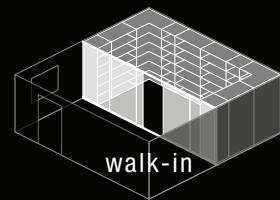

walk-in

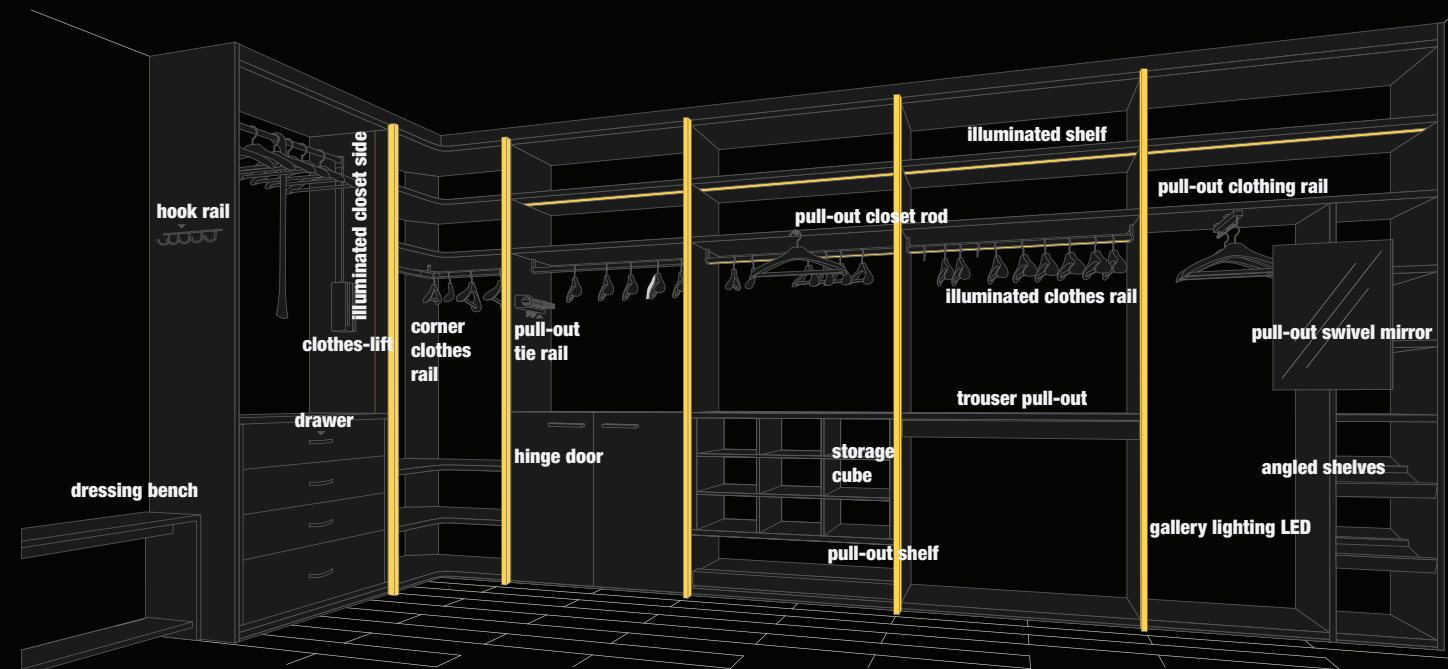

SPACE

provides an equally attractive alternative to the Trend interior system. With its classic style and elegant design, Space enhances any room, boasting many useful features. An ideal interior system for walk-in closets or anywhere one can fully appreciate the spaciousness and clean-cut look of this interior system.

SPACE – Classic and Elegant System: Made by BauCloset, adjustable height shelves present a distinctive feature in this grid-less system. Advanced options and design-oriented surfaces such as Urban Structures harmoniously enhance the look.

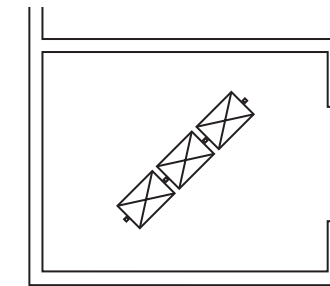
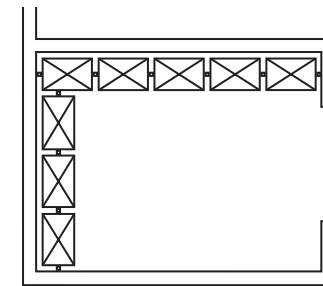
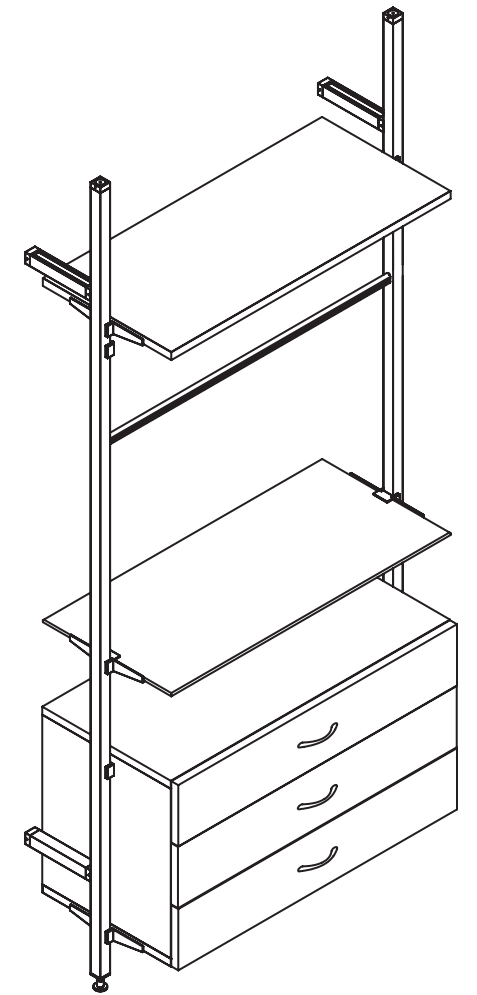



Trend and Space

are two of the times elements of customized interior design - the fitted closet, walk-in closet, living space. BauCloset provides unique storage solutions based on a diverse range of doors and interior systems to create a stylish living atmosphere. Simply combine elements from the numerous door options, selections of interior systems, and wealth of accessories to create the closet that provides you with a unique, personalized storage system.



The joy of easy access

Walk-in closets offer convenience, making getting dressed a welcome experience. Space and Trend exclusive interior systems ensure everything is at hand with pull-out rails and shelves, lights and lifts, draws and mirrors, plus many other fixtures and fittings. Choosing an outfit becomes an absolute pleasure day after day, no matter the occasion.



Tailored Inserts

Daily activity and ergonomic design aspects determine equipment arrangement which results in a closet equipped with maximum functionality. BauCloset drawer inserts in various system versions are made entirely from wood, with special ally tailored compartments for every item in your dressing room. Let yourself be inspired by this wealth of practical ideas.



Badea bathroom furniture

The Badea bathroom furniture program focusses on specific, functional design solutions for a room with so many varying needs and uses – quiet, intimacy or relaxation. Badea develops a bathing atmosphere in a variety of colors and designs, providing quality and performance. A well-defined line with noble lacquer fronts, available in different widths and combinations, this modular application and décor selection allows you to create personalized spaces unique to the needs of each user. No matter how small or large the bathroom may be, you will appreciate not only the excellence of the Badea bathroom furniture program with its intelligent lighting systems and energy-saving LED technology, mirrored cabinets and double mirrored doors.

BauTeam LV Collection

Uniquely designed and crafted vanities for extraordinary bathroom suites

ELV



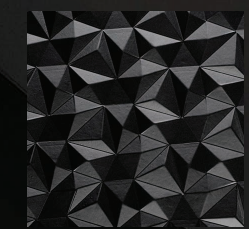
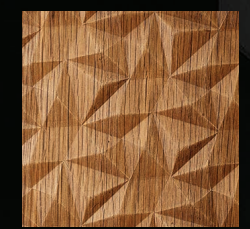

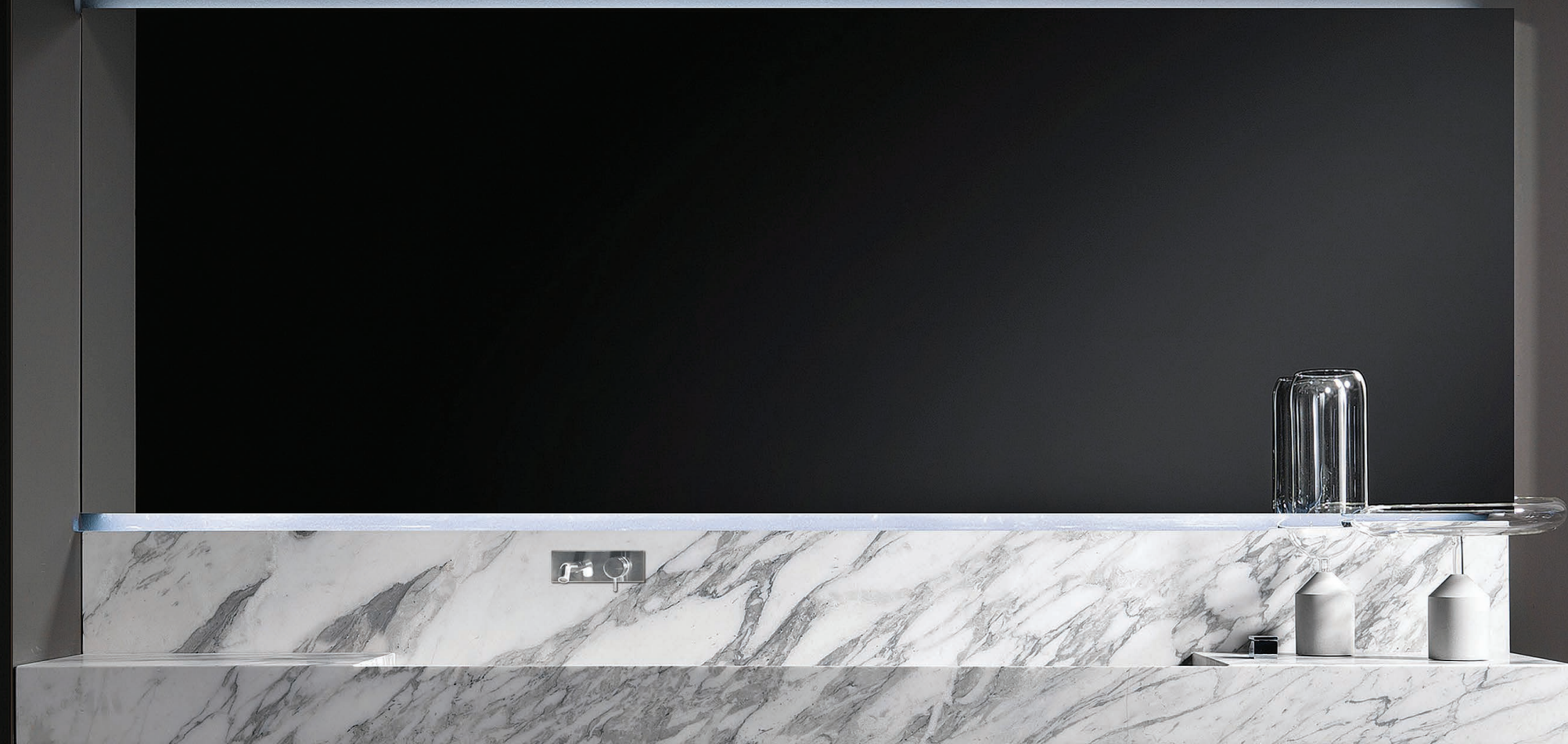



With manufacturing capacity for over 1000 kitchens daily, German quality is taken seriously at Bauformat. We invest a great deal in time and resources in professional, hi-tech production plants, efficient production techniques, high environmental standards and partner with responsible suppliers.

Bauformat cabinetry is manufactured in a state-of-the-art facility where waste is reduced to a minimum. We take great pride in our precision and the skills of our expert craftsmen make the difference.



'Quality is not an act, it is a habit.'
Aristotle



Front Design

The appearance of a kitchen is, to a very large extent, determined by the fronts. Color, material, gloss or matt; Bauformat kitchens are renowned for the high quality of their fronts. Multi-state processes in our in-house finishing lines produce flawless surface finishes, giving the kitchen a perfect look. Satin lacquer fronts are produced without harming the environment using special water-based lacquer systems. Our genuine wood fronts own their unique appearance to the use of selected wood types from sustainably managed forests, while the high quality glass owes its perfection to metal edges applied in a complex process. Stone veneer is a new material on the fronts of Bauformat kitchens.



Insert Systems

Our insert system, specially developed for Bauformat, is a niche product. It makes work in the kitchen so easy and quick. Everything is instantly on hand. The system offers practical solutions – design meets function. The influence resulting from years of experience with professional chefs can be felt with the very first use. The knife sets in the knife block – right there. There are ceramic dishes in various sizes and convenient shelves for putting something down – even spices, wooden spoons, olive oil and fresh basil, all right there within easy reach. With the Bauformat insert system, everything you need for preparing a delicious meal is right where it is needed. tzt



Quality Equipment

Creating space by means of optimum subdivision, whether it's a Le Mans and pull-out base unit or heavy-load drawer or cupboard system - it's all possible! Extras like non-slip matting and integrated LED interior lighting elevates the interior arrangements to the highest standard. Perfect waste separation and ingenious sink floor units skillfully round off the range.



Fingerprint Proof

The nanotechnological material from Bauformat has revolutionized the world of interior design. It is not only beautiful to look, but most importantly, it is also a high-tech material made unique by its characteristics. The new finish is also heat-resistant, and should the surface have superficial micro-scratches, heat actually helps to repair them. The surface of the material is scattered with a dense grid of crosspolymers with their own memory which can be reactivated by the application of heat. The new product is also water-repellant, hygienic and resistant to mold. All of these make it a perfect surface for contact with food and very easy to clean.



ELUX BAULUX



BauTeam exclusive front selection

Premium American Walnut



C Collection This fantastic new ceramic surface can be utilized for the smallest internal application in a home or office. Easy to maintain and use, a full body ceramic piece is applied to a CARB 2 compliant particle board with aluminum backing for stability and available with White of Black melamine back finish. Perfect for spaces with extensive exposure to daylight.

Basalt black

Metallo + Legna Collection From wood to metal, brass to specialties such as our Scindula (fronts with wooden shingles), the range of solutions is huge. Our source of inspiration is nature itself with its almost inexhaustible creative power. Brining beauty into people's lives in our motivation.

Struttura Collection

Inspired by the distinctive structures of natural and man-made textures, we are constantly striving to create unique surfaces that transform the cold, smooth shape and structure of interior surfaces. The geometry of moving water represents to us an example of how to visually represent the dynamics of nature in an interpretive form. Flowing, dynamic shapes give the interior landscape a straight-edge-consuming complexity and elegance, as it is only found in nature. The depth of these structures creates a distinctive and unique play of light and shadow and an unmatched blend of look and feel. Abstraction and reduced aesthetics are important, but they generate an unparalleled sculptural presence. The permanent communication with renowned designers and architects both challenges and encourages us to respond immediately to new trends.



Developed by BauTeam and made in Germany with strict quality criteria which used only components sourced from the finest European suppliers, BT45 kitchens are the result of what happens when superior materials and planning solutions unite. BT45 kitchens are furnished with a full set of sophisticated accessories made of black oak and set in a matte black finish. This luxury accessory set is designed and made in Germany with style and substance, ensuring that BT45 kitchens are never overlooked.

Open your mind to the design symphony of seamless and impeccable form, quality and materials that is BT45. With technical elegance and meticulously crafted details, Bt45 is the result when design and quality fit smoothly together with technology and innovation.



'We are the kitchen tailors'

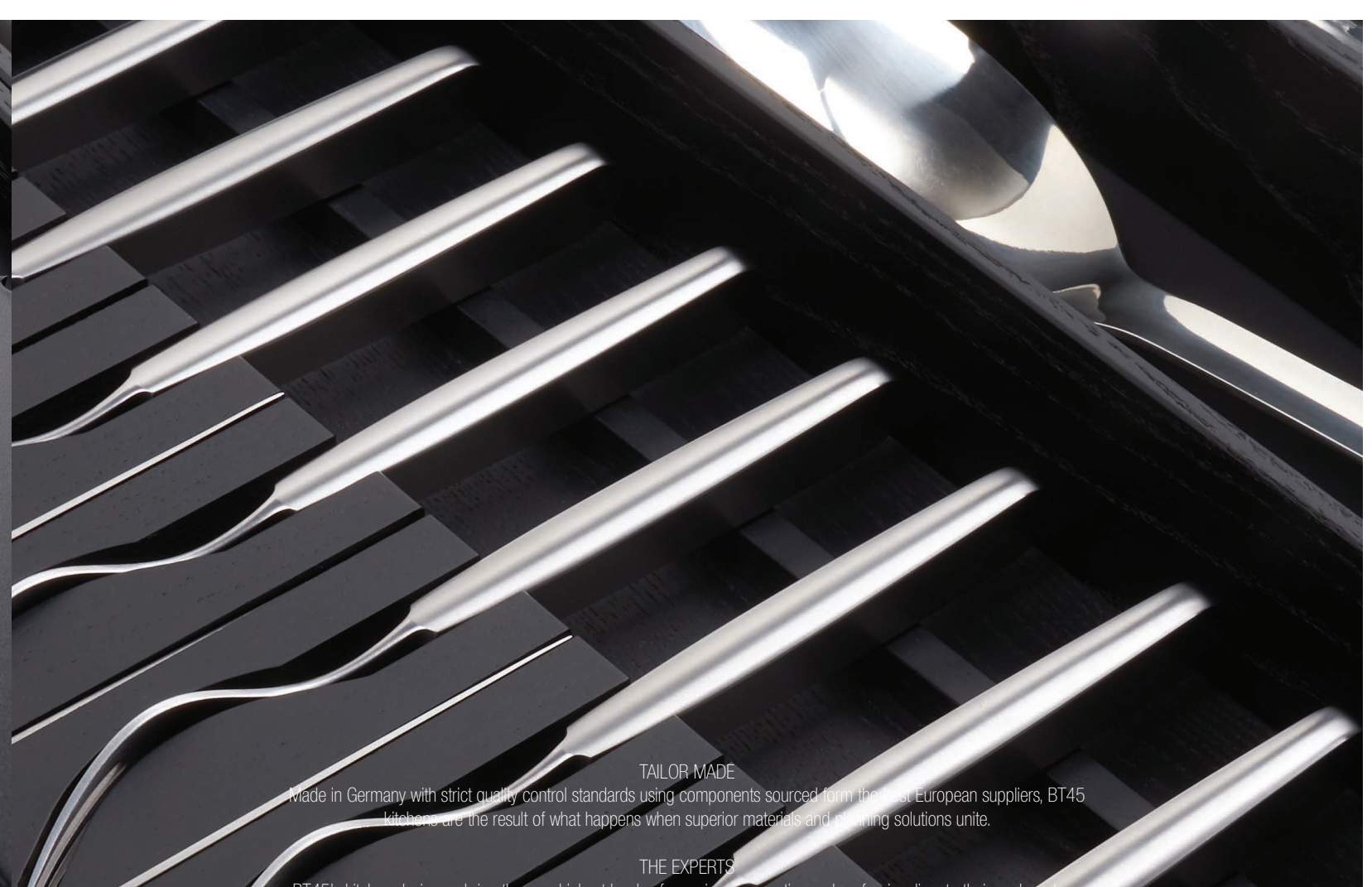

TAILOR MADE
Made in Germany with strict quality control standards using components sourced from the best European suppliers, BT45 kitchens are the result of what happens when superior materials and finishing solutions unite.

THE EXPERTS
BT45's kitchen designers bring the very highest levels of experience, expertise and professionalism to their work and are proud to uphold these standards across every project.

ELEGANCE
Beautiful finishes, such as bronzed glass, mirror, marble and tactile wood veneers bring texture and luxury to your kitchen.





BT45 MI45

Inspired by a hero of MI5 (British Military intelligence, Section 5) James Bond. This MI45 modern kitchen is designed in the best tradition of the Secret Intelligence Service Design. The super-spy "double-0 -seven" is famous by his always perfectly tailored stylish and fashionable look. He seems to know how to do everything. And he always relies on the fantastic technology which lies somewhere in the haze between reality and fiction. So is MI45 kitchen.

The most innovative German technologies, exclusive materials and tailored design are masterfully put together to make jealous the most sophisticated secret agent. 3 perfectly shaped African Saint Laurent marble blocks with real brass mitered edges. The marble blocks look magically levitating in the air. Handless bookmatched drawer fronts are designed to emphasize the capability and the technological superiority of the German manufacturing process. Each island represents a certain kitchen function with the best technologically advanced features and accessories. Lift up hidden storage reveals the kitchen tools only when you need them and keeps the minimalistic sophisticated look for the rest of the time.



BT45 PH

The original charm of a kitchen, the feeling of coming home, the sense of refuge and the scent of tasty meals – the best place to experience all this is in a kitchen built with Premium American Walnut – the aura of this Premium, soft, warm wood and its resinous fragrance creates a natural primitiveness with its own very special homely charm. Virtually no other surface finish symbolizes such perfection and is perceived as being so representative. It is instinctively in combination and attractively contrasts with the natural roughness and perfection of island crafted flawlessly with 45 degree edges in Carrara marble. The full effect of natural mood and a calming room climate unfolds in a spaciousness matching the modern alpine architecture which attaches greater value to natural materials. The architecture of the kitchen is also impressive, reduced to just a handful of elements. The freestanding cooking island in front of a row of tall units with panels that blend harmoniously with the wall.



BT45 XS

The dialogue between the dark front, seen here in Ceramic Basalt Gray effect, and genuine black leather produce an atmosphere reminiscent of a chic bar - particularly, the automated roller shutter "climber" at the bar and pocket door system which houses the BT45 coffee serving base unit. The Mile oven, coffee machine, and backlit shelf element perfectly underscore this impression just as the seamless island that emphasizes the horizontal axis with deliberately chosen Basalt Gray worktop adds character, reinforcing the solid look. The finely marbled and genuine black leather surface presents a tone of exclusivity and quality. Of course, BT45 accessories complete the kitchen! The internal drawers preserve the calm look of the front panel architecture. The light-footed cooking counter and PITT cooktop with its ceramic worktop provide the perfect workstation for gourmands with the penchant for things that are different.

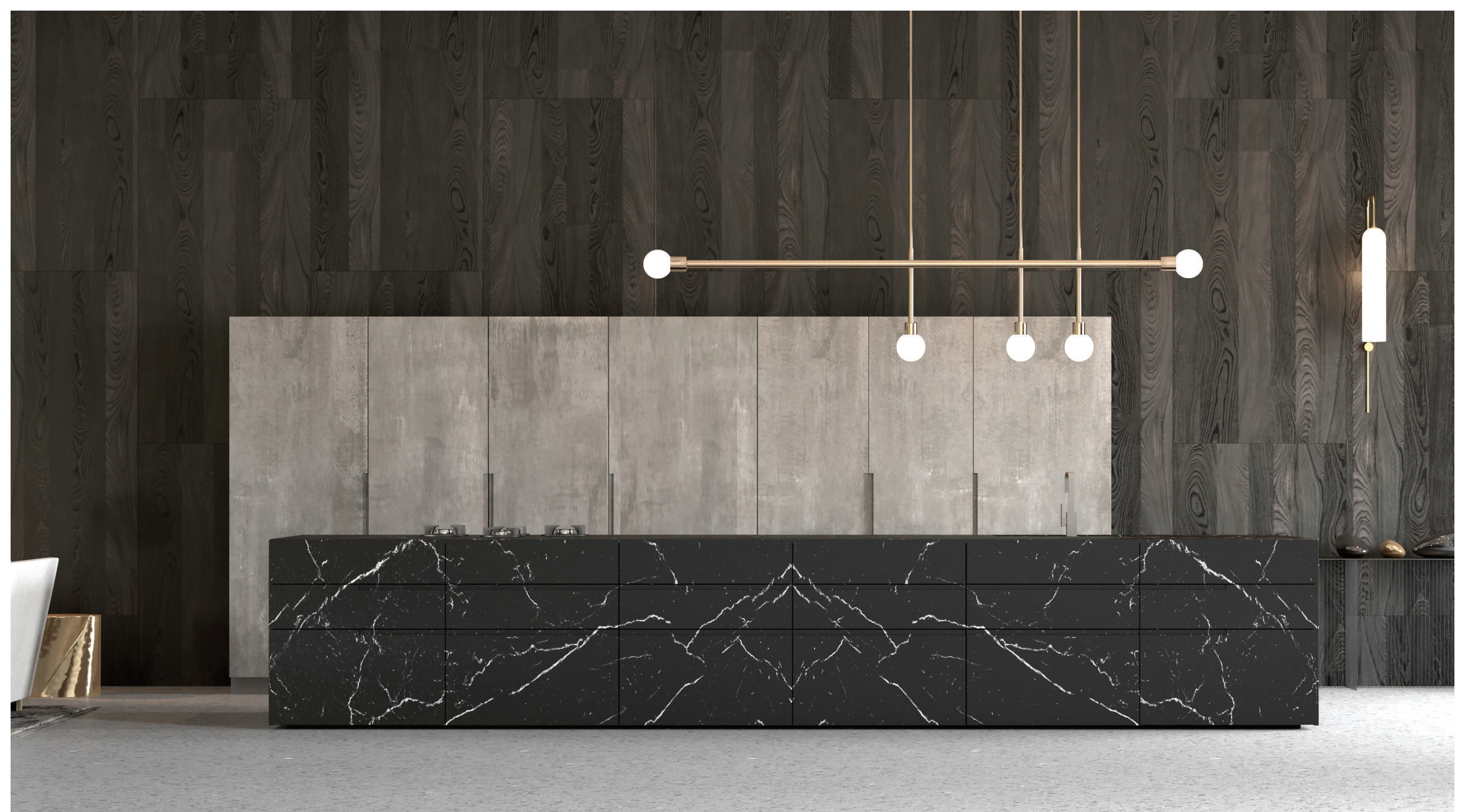

BT45 CG —

Monolithic and absolutely sublime – this generously sized kitchen block in Nero Marquina marble with its straight size defines the room in a timeless manner. It is a clear statement for a kitchen that becomes a workshop for every aspect of indulgence and enjoyment. The arrangement provides numerous benefits for professional chefs. This intelligent pocket door system which is used as storage for small cooking appliances is a particularly practical to keep items from view while the legendary glass roller shutter “Climber”, full size fridge and freezer units all combine and arranged perfectly, creating a freestanding Beton wall. A natural style gray concrete front appears to have been hewn from a single block – add to this the perfectly tailored complete inserts for drawers and pull-outs and now you’re cooking with friends.



BT45 G+

The elegant graining of the M+L Smoked French Oak veneer with its aesthetic appeal which, although understated, still makes a clear statement and turns this BT45 kitchen into a piece that is nothing short of exceptional. The contrast of White Quartzite and smoked glass doors with brushed stainless-steel frame lends memorable impact with its intentional contrast. Continuing this theme, the minimalist cooking table and hidden cooktop pay a central part in the kitchen's architecture. Matching it, the 45-degree mitered edge panel, front and counter system combine function and flatters the kitchen. The base units, with their extra low plinth of only 2 cm, as well as the interior drawers with integrated lighting compliment the kitchen uniformly.

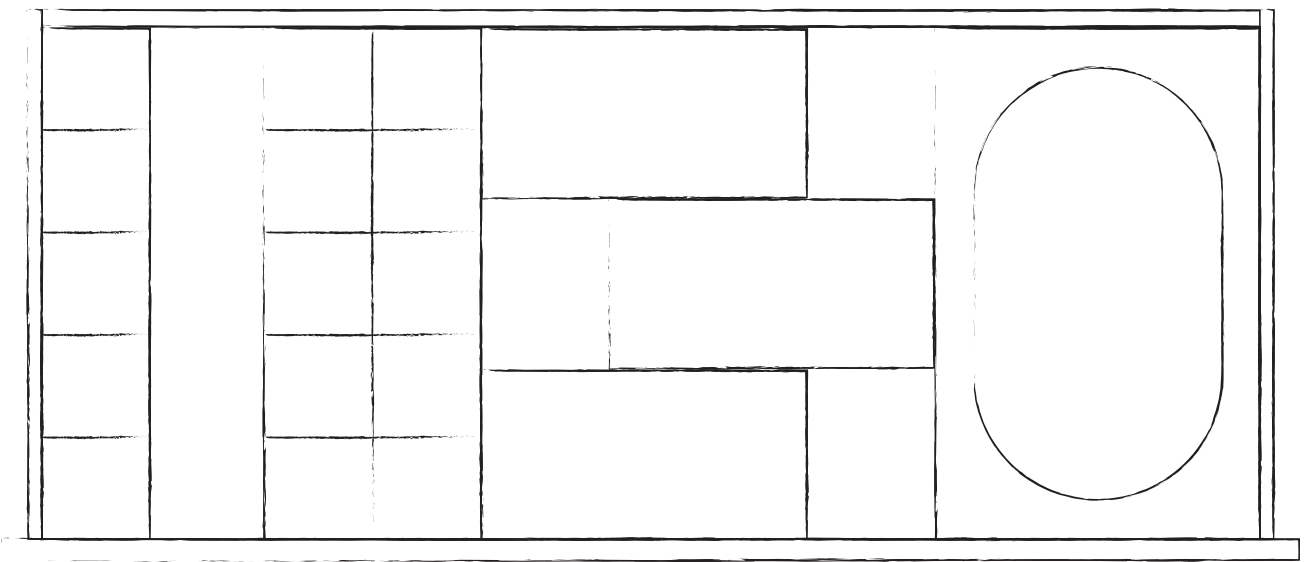

German made with unsurpassed technology

Since 1921, our kitchens have been telling the story of creativity and German design which are forever tied to innovation and quality. All components are manufactured and fully assembled in Germany to exacting standards using laser-scanning technology. This gives our team complete confidence that we are delivering superior workmanship that you are unlikely to find from local joiners. Attention to detail, the finest materials and design innovation all work seamlessly together to give life to an exclusive German tailored kitchen. It's not just about realizing beautiful aesthetics, Tailored Kitchens provide reliability and peace-of-mind For a long-lasting kitchen in your home.

THEBAUTEAM.COM

BAUFORMATUSA.COM

BAU-LUX.COM

BT45.DE

BAUCLOSET.COM

